

**All+**  
THE URBAN STYLE

**LOCO**

# LOCO

Schienale curvo doppio, seduta curva, senza piede con fissaggio a pavimento.

**A** Double curved back, curved seat, no feet with floor fixing.

	CODICE ARTICOLO	ITEM CODE	Icona persona	Icona Kg	Icona m <sup>3</sup>	FINITURE > FINISHES		
						Alluminio anodizzato naturale Natural anodised Aluminium	All. verniciato bianco goffrato RAL 9010 Embossed white Aluminium RAL 9010	Laminato Abet bianco 819 rosso 431-grigio 879 Abet laminate white 819 red 431-grey 879
						IVA non imponibile > Not subject to VAT **		
	L02PAmf	2	45	*	1.350	1.380	1.490	
	L04PAbf	4	70	*	2.140	2.200	2.420	
	L03PAmf	3	60	*	1.670	1.710	1.860	
	L06PAbf	6	95	*	2.750	2.840	3.040	
	L04PAmf	4	70	*	2.000	2.060	2.180	
	L08PAbf	8	120	*	3.370	3.480	3.740	
	L05PAmf	5	85	*	2.340	2.410	2.530	
	L010PAbf	10	145	*	4.010	4.150	4.360	
	L06PAmf	6	115	*	3.220	3.310	3.560	
	L012PAbf	12	190	*	5.370	5.540	5.850	

> È possibile richiedere dimensioni fuori serie, contattando il nostro ufficio tecnico. Per le versioni in alluminio verniciato e con laminato è possibile richiedere colori a campione, contattando il nostro ufficio commerciale per fattibilità, costo e quantitativi minimi per ordine. Tutte le dimensioni ed i pesi sono soggetti alle normali tolleranze commerciali.









> Contact our technical office for any non-standard dimensions. Sample colours are available for versions in painted aluminium or laminate. Contact our sales office for feasibility, costs and minimum order quantities. All dimensions and weights are subject to the normal commercial tolerances.

\* I volumi saranno calcolabili dall'azienda solo a preventivo. > The volumes will be calculated by the company for the quotation only. \*\*art. 8 dpr 26/10/72 n° 633 e succ. mod. dpr 29/01/79 n°24 del 31/03/94

# LOCO

Schienale curvo doppio, seduta curva, senza piede con fissaggio a pavimento.

**A** Double curved back, curved seat, no feet with floor fixing.

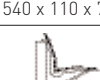
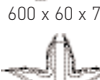
	CODICE ARTICOLO ITEM CODE				FINITURE > FINISHES		
					Alluminio anodizzato naturale Natural anodised Aluminium	All. verniciato bianco goffrato RAL 9010 Embossed white Aluminium RAL 9010	Laminato Abet bianco 819 rosso 431-grigio 879 Abet laminate white 819 red 431-grey 879
IVA non imponibile > Not subject to VAT **							
 420 x 60 x 78	LO7PAmf	7	130	*	3.620	3.720	3.980
 420 x 110 x 78	LO14PAbf	14	215	*	6.120	6.310	6.790
 480 x 60 x 78	LO8PAmf	8	140	*	3.910	4.020	4.250
 480 x 110 x 78	LO16PAbf	16	240	*	6.690	6.900	7.360
 540 x 60 x 78	LO9PAmf	9	160	*	4.300	4.430	4.660
 540 x 110 x 78	LO18PAbf	18	270	*	7.390	7.640	8.100
 600 x 60 x 78	LO10PAmf	10	170	*	4.590	4.730	4.950
 600 x 110 x 78	LO20PAbf	20	290	*	7.970	8.240	8.660

» È possibile richiedere dimensioni fuori serie, contattando il nostro ufficio tecnico. Per le versioni in alluminio verniciato e con laminato è possibile richiedere colori a campione, contattando il nostro ufficio commerciale per fattibilità, costo e quantitativi minimi per ordine. Tutte le dimensioni ed i pesi sono soggetti alle normali tolleranze commerciali.











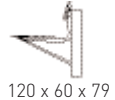

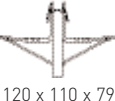

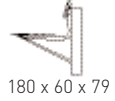

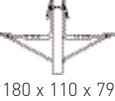

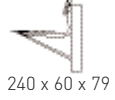
» Contact our technical office for any non-standard dimensions. Sample colours are available for versions in painted aluminium or laminate. Contact our sales office for feasibility, costs and minimum order quantities. All dimensions and weights are subject to the normal commercial tolerances.

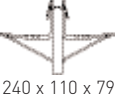
\* I volumi saranno calcolabili dall'azienda solo a preventivo. » The volumes will be calculated by the company for the quotation only. \*\*art. 8 DPR 26/10/72 n° 633 e succ. mod. DPR 29/01/79 n°24 del 31/03/94

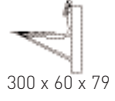
# LOCO

Schienale curvo singolo, seduta curva, senza piede con fissaggio a pavimento.

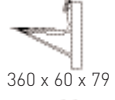
**B** Single curved back, curved seat, no feet with floor fixing.

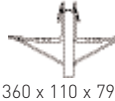
	CODICE ARTICOLO	ITEM CODE	Icona persona	Icona Kg	Icona m <sup>3</sup>	FINITURE > FINISHES		
						Alluminio anodizzato naturale Natural anodised Aluminium	All. verniciato bianco goffrato RAL 9010 Embossed white Aluminium RAL 9010	Laminato Abet bianco 819 rosso 431-grigio 879 Abet laminate white 819 red 431-grey 879
IVA non imponibile > Not subject to VAT **								
 120 x 60/110 x 79	 L02PBmf 120 x 60 x 79	2	45	*	1.240	1.260	1.350	
 120 x 60/110 x 79	 L04BAbf 120 x 110 x 79	4	70	*	1.910	1.950	2.130	
 180 x 60/110 x 79	 L03PBmf 180 x 60 x 79	3	60	*	1.510	1.540	1.650	
 180 x 60/110 x 79	 L06PBbf 180 x 110 x 79	6	95	*	2.410	2.470	2.660	
 240 x 60/110 x 79	 L04PBmf 240 x 60 x 79	4	70	*	1.780	1.820	1.940	
 240 x 60/110 x 79	 L08PBbf 240 x 110 x 79	8	120	*	2.920	3.000	3.250	
 300 x 60/110 x 79	 L05PBmf 300 x 60 x 79	5	85	*	2.070	2.120	2.230	
 300 x 60/110 x 79	 L010PBbf 300 x 110 x 79	10	145	*	3.450	3.550	3.770	
 360 x 60/110 x 79	 L06PBmf 360 x 60 x 79	6	115	*	2.890	2.950	3.160	
 360 x 60/110 x 79	 L012PBbf 360 x 110 x 79	12	190	*	4.680	4.810	5.100	

> È possibile richiedere dimensioni fuori serie, contattando il nostro ufficio tecnico. Per le versioni in alluminio verniciato e con laminato è possibile richiedere colori a campione, contattando il nostro ufficio commerciale per fattibilità, costo e quantitativi minimi per ordine. Tutte le dimensioni ed i pesi sono soggetti alle normali tolleranze commerciali.











> Contact our technical office for any non-standard dimensions. Sample colours are available for versions in painted aluminium or laminate. Contact our sales office for feasibility, costs and minimum order quantities. All dimensions and weights are subject to the normal commercial tolerances.

\* I volumi saranno calcolabili dall'azienda solo a preventivo. > The volumes will be calculated by the company for the quotation only. \*\*art. 8 dpr 26/10/72 n° 633 e succ. mod. dpr 29/01/79 n°24 del 31/03/94

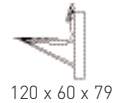
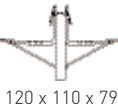
# LOCO

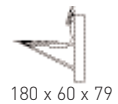
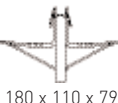
Schienale curvo singolo, seduta curva, senza piede con fissaggio a pavimento.

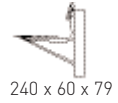
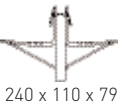
**B** Single curved back, curved seat, no feet with floor fixing.

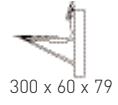
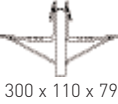
	CODICE ARTICOLO	ITEM CODE				FINITURE > FINISHES		
						Alluminio anodizzato naturale Natural anodised Aluminium	All. verniciato bianco goffrato RAL 9010 Embossed white Aluminium RAL 9010	Laminato Abet bianco 819 rosso 431-grigio 879 Abet laminate white 819 red 431-grey 879
						IVA non imponibile > Not subject to VAT **		
 120 x 60/110 x 79	 120 x 60 x 79	L07PBmf	7	130	*	3.220	3.290	3.520
	 120 x 110 x 79	L014PBbf	14	215	*	5.290	5.430	5.880
 180 x 60/110 x 79	 180 x 60 x 79	L08PBmf	8	140	*	3.450	3.530	3.750
	 180 x 110 x 79	L016PBbf	16	240	*	5.760	5.920	6.350
 240 x 60/110 x 79	 240 x 60 x 79	L09PBmf	9	160	*	3.790	3.880	4.100
	 240 x 110 x 79	L018PBbf	18	270	*	6.350	6.530	6.990
 300 x 60/110 x 79	 300 x 60 x 79	L010PBmf	10	170	*	4.020	4.120	4.330
	 300 x 110 x 79	L020PBbf	20	290	*	6.820	7.020	7.450

> È possibile richiedere dimensioni fuori serie, contattando il nostro ufficio tecnico. Per le versioni in alluminio verniciato e con laminato è possibile richiedere colori a campione, contattando il nostro ufficio commerciale per fattibilità, costo e quantitativi minimi per ordine. Tutte le dimensioni ed i pesi sono soggetti alle normali tolleranze commerciali.









> Contact our technical office for any non-standard dimensions. Sample colours are available for versions in painted aluminium or laminate. Contact our sales office for feasibility, costs and minimum order quantities. All dimensions and weights are subject to the normal commercial tolerances.

\* I volumi saranno calcolabili dall'azienda solo a preventivo. > The volumes will be calculated by the company for the quotation only. \*\*art. 8 DPR 26/10/72 n° 633 e succ. mod. DPR 29/01/79 n°24 del 31/03/94

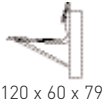
# LOCO

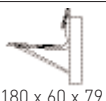
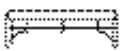
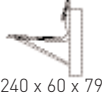
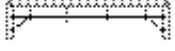
Schienale piatto singolo, seduta piatta, senza piede con fissaggio a pavimento.

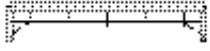
**C** Single flat back, flat seat, no feet with floor fixing.

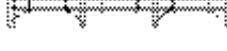
	CODICE ARTICOLO	ITEM CODE				FINITURE > FINISHES		
						Alluminio anodizzato naturale Natural anodised Aluminium	All. verniciato bianco goffrato RAL 9010 Embossed white Aluminium RAL 9010	Laminato Abet bianco 819 rosso 431-grigio 879 Abet laminate white 819 red 431-grey 879
 120 x 60 x 79	L02PCmf	2	45	*	1.220	1.230	1.330	
 120 x 60/110 x 79	L04PCbf	4	70	*	1.860	1.900	2.100	
 180 x 60 x 79	L03PCmf	3	60	*	1.470	1.500	1.620	
 180 x 60/110 x 79	L06PCbf	6	95	*	2.340	2.400	2.600	
 240 x 60 x 79	L04PCmf	4	70	*	1.740	1.770	1.900	
 240 x 60/110 x 79	L08PCbf	8	120	*	2.830	2.910	3.170	
 300 x 60 x 79	L05PCmf	5	85	*	2.010	2.060	2.180	
 300 x 60/110 x 79	L010PCbf	10	145	*	3.340	3.430	3.690	
 360 x 60 x 79	L06PCmf	6	115	*	2.820	2.880	3.100	
 360 x 60/110 x 79	L012PCbf	12	190	*	4.550	4.660	4.980	

È possibile richiedere dimensioni fuori serie, contattando il nostro ufficio tecnico. Per le versioni in alluminio verniciato e con laminato è possibile richiedere colori a campione, contattando il nostro ufficio commerciale per fattibilità, costo e quantitativi minimi per ordine. Tutte le dimensioni ed i pesi sono soggetti alle normali tolleranze commerciali.







Contact our technical office for any non-standard dimensions. Sample colours are available for versions in painted aluminium or laminate. Contact our sales office for feasibility, costs and minimum order quantities. All dimensions and weights are subject to the normal commercial tolerances.

\* I volumi saranno calcolabili dall'azienda solo a preventivo. > The volumes will be calculated by the company for the quotation only. \*\*art. 8 dpr 26/10/72 n° 633 e succ. mod. dpr 29/01/79 n°24 del 31/03/94

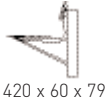
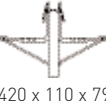
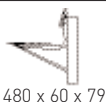
# LOCO

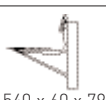
Schienale piatto singolo, seduta piatta, senza piede con fissaggio a pavimento.

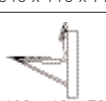
**C** Single flat back, flat seat, no feet with floor fixing.

CODICE ARTICOLO	ITEM CODE	Icona persona	Icona Kg	Icona m <sup>2</sup>	FINITURE > FINISHES		
					Alluminio anodizzato naturale Natural anodised Aluminium	All. verniciato bianco goffrato RAL 9010 Embossed white Aluminium RAL 9010	Laminato Abet bianco 819 rosso 431-grigio 879 Abet laminate white 819 red 431-grey 879
IVA non imponibile > Not subject to VAT **							
 420 x 60 x 79	L07PCmf	7	130	*	3.140	3.210	3.450
 420 x 110 x 79	L014PCbf	14	215	*	5.130	5.270	5.740
 480 x 60 x 79	L08PCmf	8	140	*	3.360	3.440	3.660
 480 x 110 x 79	L016PCbf	16	240	*	5.580	5.730	6.190
 540 x 60 x 79	L09PCmf	9	160	*	3.690	3.770	4.010
 540 x 110 x 79	L018PCbf	18	270	*	6.150	6.310	6.810
 600 x 60 x 79	L010PCmf	10	170	*	3.910	4.000	4.230
 600 x 110 x 79	L020PCbf	20	290	*	6.600	6.780	7.250

È possibile richiedere dimensioni fuori serie, contattando il nostro ufficio tecnico. Per le versioni in alluminio verniciato e con laminato è possibile richiedere colori a campione, contattando il nostro ufficio commerciale per fattibilità, costo e quantitativi minimi per ordine. Tutte le dimensioni ed i pesi sono soggetti alle normali tolleranze commerciali.

Contact our technical office for any non-standard dimensions. Sample colours are available for versions in painted aluminium or laminate. Contact our sales office for feasibility, costs and minimum order quantities. All dimensions and weights are subject to the normal commercial tolerances.













\* I volumi saranno calcolabili dall'azienda solo a preventivo. \* The volumes will be calculated by the company for the quotation only. \*\*art. 8 DPR 26/10/72 n° 633 e succ. mod. DPR 29/01/79 n°24 del 31/03/94

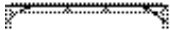

# LOCO

Senza schienale, seduta piatta,  
senza piede con fissaggio a pavimento.

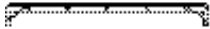
**D** No back, flat seat,  
no feet with floor fixing.

	CODICE ARTICOLO	ITEM CODE				FINITURE > FINISHES		
						Alluminio anodizzato naturale	All. verniciato bianco goffrato RAL 9010	Laminato Abet bianco 819 rosso 431-grigio 879
						Natural anodised Aluminium	Embossed white Aluminium RAL 9010	Abet laminate white 819 red 431-grey 879
IVA non imponibile > Not subject to VAT **								
 120 x 62 x 45	L02PDmf		2	40	*	1.180	1.200	1.280
 120 x 62/103 x 45	L04PDbf		4	50	*	1.620	1.650	1.780
 180 x 62 x 45	L03PDmf		3	50	*	1.420	1.500	1.550
 180 x 62/103 x 45	L06PDbf		6	80	*	2.000	2.050	2.180
 240 x 62 x 45	L04PDmf		4	60	*	1.710	1.740	1.840
 240 x 62/103 x 45	L08PDbf		8	85	*	2.400	2.460	2.630
 300 x 62 x 45	L05PDmf		5	70	*	1.980	2.020	2.110
 300 x 62/103 x 45	L010PDbf		10	100	*	2.810	2.890	3.040
 360 x 62 x 45	L06PDmf		6	90	*	2.730	2.770	3.000
 360 x 62/103 x 45	L012PDbf		12	130	*	3.870	3.950	4.210

> È possibile richiedere dimensioni fuori serie, contattando il nostro ufficio tecnico. Per le versioni in alluminio verniciato e con laminato è possibile richiedere colori a campione, contattando il nostro ufficio commerciale per fattibilità, costo e quantitativi minimi per ordine. Tutte le dimensioni ed i pesi sono soggetti alle normali tolleranze commerciali.











> Contact our technical office for any non-standard dimensions. Sample colours are available for versions in painted aluminium or laminate. Contact our sales office for feasibility, costs and minimum order quantities. All dimensions and weights are subject to the normal commercial tolerances.

\* I volumi saranno calcolabili dall'azienda solo a preventivo. > The volumes will be calculated by the company for the quotation only. \*\*art. 8 dpr 26/10/72 n° 633 e succ. mod. dpr 29/01/79 n°24 del 31/03/94

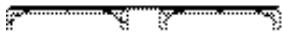
# LOCO

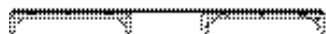
Senza schienale, seduta piatta,  
senza piede con fissaggio a pavimento.

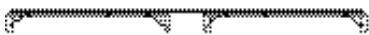
**D** No back, flat seat,  
no feet with floor fixing.

	CODICE ARTICOLO	ITEM CODE				FINITURE > FINISHES		
						Alluminio anodizzato naturale	All. verniciato bianco goffrato RAL 9010	Laminato Abet bianco 819 rosso 431-grigio 879
						Natural anodised Aluminium	Embossed white Aluminium RAL 9010	Abet laminate white 819 red 431-grey 879
IVA non imponibile > Not subject to VAT **								
 420 x 62 x 45	L07PDmf	7	100	*	3.080	3.130	3.350	
 420 x 62/103 x 45	L014PDbf	14	150	*	4.350	4.440	4.790	
 480 x 62 x 45	L08PDmf	8	110	*	3.300	3.390	3.610	
 480 x 62/103 x 45	L016PDbf	16	160	*	4.700	4.830	5.190	
 540 x 62 x 45	L09PDmf	9	125	*	3.630	3.680	3.890	
 540 x 62/103 x 45	L018PDbf	18	180	*	5.170	5.260	5.610	
 600 x 62 x 45	L010PDmf	10	130	*	3.850	3.950	4.160	
 600 x 62/103 x 45	L020PDbf	20	195	*	5.520	5.670	6.010	







È possibile richiedere dimensioni fuori serie, contattando il nostro ufficio tecnico. Per le versioni in alluminio verniciato e con laminato è possibile richiedere colori a campione, contattando il nostro ufficio commerciale per fattibilità, costo e quantitativi minimi per ordine. Tutte le dimensioni ed i pesi sono soggetti alle normali tolleranze commerciali.

Contact our technical office for any non-standard dimensions. Sample colours are available for versions in painted aluminium or laminate. Contact our sales office for feasibility, costs and minimum order quantities. All dimensions and weights are subject to the normal commercial tolerances.

\* I volumi saranno calcolabili dall'azienda solo a preventivo. \* The volumes will be calculated by the company for the quotation only. \*\*art. 8 DPR 26/10/72 n° 633 e succ. mod. DPR 29/01/79 n°24 del 31/03/94

# LOCO

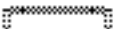
**E** Panca singola 2 doghe.  
Single bench 2 panel strip.

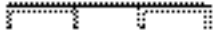
	CODICE ARTICOLO ITEM CODE				FINITURE > FINISHES		
					Alluminio anodizzato naturale Natural anodised Aluminium	All. verniciato bianco goffrato RAL 9010 Embossed white Aluminium RAL 9010	Laminato Abet bianco 819 rosso 431-grigio 879 Abet laminate white 819 red 431-grey 879
IVA non imponibile > Not subject to VAT **							
 120 x 41/120 x 45	LO2PDbf	2	25	*	930	940	990
 180 x 41/120 x 45	LO3PDbf	3	35	*	1.140	1.150	1.200
 240 x 41/300 x 45	LO4PDbf	4	45	*	1.350	1.380	1.440
 300 x 41/360 x 45	LO5PDbf	5	55	*	1.580	1.610	1.670
 360 x 41/360 x 45	LO6PDbf	6	65		2.130	2.160	2.220







> È possibile richiedere dimensioni fuori serie, contattando il nostro ufficio tecnico. Per le versioni in alluminio verniciato e con laminato è possibile richiedere colori a campione, contattando il nostro ufficio commerciale per fattibilità, costo e quantitativi minimi per ordine. Tutte le dimensioni ed i pesi sono soggetti alle normali tolleranze commerciali.

> Contact our technical office for any non-standard dimensions. Sample colours are available for versions in painted aluminium or laminate. Contact our sales office for feasibility, costs and minimum order quantities. All dimensions and weights are subject to the normal commercial tolerances.

\* I volumi saranno calcolabili dall'azienda solo a preventivo. > The volumes will be calculated by the company for the quotation only. \*\*art. 8 dpr 26/10/72 n° 633 e succ. mod. dpr 29/01/79 n°24 del 31/03/94

# LOCO

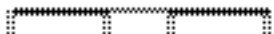
**E** Panca singola 2 doghe.  
Single bench 2 panel strip.









	CODICE ARTICOLO ITEM CODE				FINITURE > FINISHES		
					Alluminio anodizzato naturale Natural anodised Aluminium	All. verniciato bianco goffrato RAL 9010 Embossed white Aluminium RAL 9010	Laminato Abet bianco 819 rosso 431-grigio 879 Abet laminate white 819 red 431-grey 879
IVA non imponibile > Not subject to VAT **							
 420 x 41/420 x 45	LO7PDbf	2	75	*	2.390	2.430	2.510
 480 x 41/480 x 45	LO8PDbf	3	85	*	2.590	2.640	2.720
 540 x 41/540 x 45	LO9PDbf	4	95	*	2.810	2.870	2.960
 600 x 41/600 x 45	LO10PDbf	5	105	*	3.020	3.090	3.180

> È possibile richiedere dimensioni fuori serie, contattando il nostro ufficio tecnico. Per le versioni in alluminio verniciato e con laminato è possibile richiedere colori a campione, contattando il nostro ufficio commerciale per fattibilità, costo e quantitativi minimi per ordine. Tutte le dimensioni ed i pesi sono soggetti alle normali tolleranze commerciali.  
> Contact our technical office for any non-standard dimensions. Sample colours are available for versions in painted aluminium or laminate. Contact our sales office for feasibility, costs and minimum order quantities. All dimensions and weights are subject to the normal commercial tolerances.

\* I volumi saranno calcolabili dall'azienda solo a preventivo. > The volumes will be calculated by the company for the quotation only. \*\*art. 8 dpr 26/10/72 n° 633 e succ. mod. dpr 29/01/79 n°24 del 31/03/94

# LOCO

**F** Attesa breve.  
Short stay.

		CODICE ARTICOLO	Kg	m <sup>3</sup>	FINITURE > FINISHES
					ITEM CODE
					IVA non imponibile > Not subject to VAT **
		L02PF	6	*	650
120 x 71	11 x 71				
		L03PF	8	*	720
180 x 71	11 x 71				
		L04PF	10	*	800
240 x 71	11 x 71				
		L05PF	12	*	890
300 x 71	11 x 71				
Accessorio appendi bagaglio Baggage hanger accessory		L0AAB		*	
					
120/180/240/300					

› È possibile richiedere dimensioni fuori serie, contattando il nostro ufficio tecnico. Per le versioni in alluminio verniciato e con laminato è possibile richiedere colori a campione, contattando il nostro ufficio commerciale per fattibilità, costo e quantitativi minimi per ordine. Tutte le dimensioni ed i pesi sono soggetti alle normali tolleranze commerciali.

› Contact our technical office for any non-standard dimensions. Sample colours are available for versions in painted aluminium or laminate. Contact our sales office for feasibility, costs and minimum order quantities. All dimensions and weights are subject to the normal commercial tolerances.

\* I volumi saranno calcolabili dall'azienda solo a preventivo. › The volumes will be calculated by the company for the quotation only. \*\*art. 8 DPR 26/10/72 n° 633 e succ. mod. DPR 29/01/79 n°24 del 31/03/94

## Accessori.

## Accessories.

dimensioni panca dimension	CUSCINO IN TECNOGEL* › CUSHION IN TECNOGEL*		PIEDI › FEET			
	n°cuscini › n°cushions		q.tà q.ty		q.tà q.ty	
L = 120	2	4	2	180	2	180
	4	8	2	390	2	390
L = 180	3	6	2	180	2	180
	6	12	2	390	2	390
L = 240	4	8	2	180	2	180
	8	16	2	390	2	390
L = 300	5	10	2	180	2	180
	10	20	2	390	2	390
L = 360	6	12	4	360	4	360
	12	24	4	780	4	780
L = 420	7	14	4	360	4	360
	14	28	4	780	4	780
L = 480	8	16	4	360	4	360
	16	32	4	780	4	780
L = 540	9	18	4	360	4	360
	18	36	4	780	4	780
L = 600	10	20	4	360	4	360
	20	40	4	780	4	780









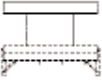

› È possibile richiedere dimensioni fuori serie, contattando il nostro ufficio tecnico. Per le versioni in alluminio verniciato e con laminato è possibile richiedere colori a campione, contattando il nostro ufficio commerciale per fattibilità, costo e quantitativi minimi per ordine. Tutte le dimensioni ed i pesi sono soggetti alle normali tolleranze commerciali.

› Contact our technical office for any non-standard dimensions. Sample colours are available for versions in painted aluminium or laminate. Contact our sales office for feasibility, costs and minimum order quantities. All dimensions and weights are subject to the normal commercial tolerances.

\* I volumi saranno calcolabili dall'azienda solo a preventivo. › The volumes will be calculated by the company for the quotation only. \*\*art. 8 DPR 26/10/72 n° 633 e succ. mod. DPR 29/01/79 n°24 del 31/03/94

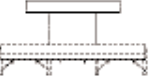
# LOCO

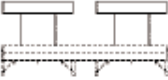
Insegna orizzontale.  
Horizontal sign.

				FINITURE > FINISHES	
		CODICE ARTICOLO	Kg	Insegna bifacciale in profilo di alluminio anodizzato argento. Inclusi: telaio interno in tubolare di ferro zincato, pannelli in plexiglass opal bianco mm.3. (escluso impianto luminoso tubi neon fluorescenti).	
		ITEM CODE		Double sided signs in anodised aluminium. Included internal galvanised steel frame and white Plexiglas panels thick. 3mm (fluorescent lamps not included).	
				IVA non imponibile > Not subject to VAT **	
		LOIO1801	4	1.160	
180 (180 x 1)	180 x 30 x 10				
		LOIO2401	6	1.390	
240 (240 x 1)	240 x 30 x 10				
		LOIO2401	6	1.390	
300 (240 x 1)	240 x 30 x 10				
		LOIO2401	6	1.390	
360 (240 x 1)	240 x 30 x 10				
		LOIO1802	8	2.320	
420 (180 x 2)	180 x 30 x 10				

> È possibile richiedere dimensioni fuori serie, contattando il nostro ufficio tecnico. Per le versioni in alluminio verniciato e con laminato è possibile richiedere colori a campione, contattando il nostro ufficio commerciale per fattibilità, costo e quantitativi minimi per ordine. Tutte le dimensioni ed i pesi sono soggetti alle normali tolleranze commerciali.

> Contact our technical office for any non-standard dimensions. Sample colours are available for versions in painted aluminium or laminate. Contact our sales office for feasibility, costs and minimum order quantities. All dimensions and weights are subject to the normal commercial tolerances.

\* I volumi saranno calcolabili dall'azienda solo a preventivo. > The volumes will be calculated by the company for the quotation only. \*\*art. 8 DPR 26/10/72 n° 633 e succ. mod. DPR 29/01/79 n°24 del 31/03/94

# LOCO

Insegna orizzontale.  
Horizontal sign.



480 (180 x 2)

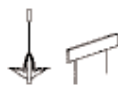

180 x 30 x 10

LOIO1802

8

2.320



540 (240 x 2)

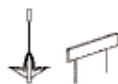

240 x 30 x 10

LOIO2402

12

2.780



600 (240 x 2)

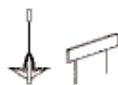

240 x 30 x 10

LOIO2402

12

2.780

## FINITURE > FINISHES

Insegna bifacciale in profilo di alluminio anodizzato argento.  
Inclusi: telaio interno in tubolare di ferro zincato, pannelli in plexiglass opal bianco mm.3. (escluso impianto luminoso tubi neon fluorescenti).











Double sided signs in anodised aluminium.  
Included internal galvanised steel frame and white Plexiglas panels thick. 3mm (fluorescent lamps not included).

IVA non imponibile > Not subject to VAT \*\*

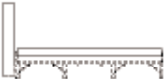

# LOCO

Insegna verticale.  
Vertical sign.

				FINITURE > FINISHES	
		CODICE ARTICOLO	Kg	Insegna bifacciale in profilo di alluminio anodizzato argento. Inclusi: telaio interno in tubolare di ferro zincato, pannelli in plexiglass opal bianco mm.3. (escluso impianto luminoso tubi neon fluorescenti).	
		ITEM CODE		Double sided signs in anodised aluminium. Included internal galvanised steel frame and white Plexiglas panels thick. 3mm (fluorescent lamps not included).	
				IVA non imponibile > Not subject to VAT **	
		LOIV180	4	920	
180	180 x 30 x 10				
		LOIV180	4	920	
240	180 x 30 x 11				
		LOIV180	4	920	
300	180 x 30 x 11				
		LOIV180	4	920	
360	180 x 30 x 11				
		LOIV180	4	920	
420	180 x 30 x 11				

> È possibile richiedere dimensioni fuori serie, contattando il nostro ufficio tecnico. Per le versioni in alluminio verniciato e con laminato è possibile richiedere colori a campione, contattando il nostro ufficio commerciale per fattibilità, costo e quantitativi minimi per ordine. Tutte le dimensioni ed i pesi sono soggetti alle normali tolleranze commerciali.

> Contact our technical office for any non-standard dimensions. Sample colours are available for versions in painted aluminium or laminate. Contact our sales office for feasibility, costs and minimum order quantities. All dimensions and weights are subject to the normal commercial tolerances.

\* I volumi saranno calcolabili dall'azienda solo a preventivo. > The volumes will be calculated by the company for the quotation only. \*\*art. 8 DPR 26/10/72 n° 633 e succ. mod. DPR 29/01/79 n°24 del 31/03/94

# LOCO

Insegna verticale.  
Vertical sign.



480 (180 x 2)

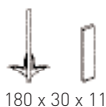

180 x 30 x 11

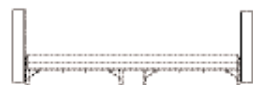

540 (180 x 2)

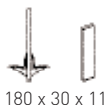

180 x 30 x 11



600 (180 x 2)

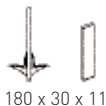

180 x 30 x 11

CODICE ARTICOLO	ITEM CODE	Kg	FINITURE > FINISHES	
			IVA non imponibile > Not subject to VAT **	
			Insegna bifacciale in profilo di alluminio anodizzato argento. Inclusi: telaio interno in tubolare di ferro zincato, pannelli in plexiglass opal bianco mm.3. (escluso impianto luminoso tubi neon fluorescenti).  Double sided signs in anodised aluminium. Included internal galvanised steel frame and white Plexiglas panels thick. 3mm (fluorescent lamps not included).	
LOIV1802	8		1840	
LOIV1802	8		1840	
LOIV1802	8		1840	

Dissuasore.  
Bollard.



LOD

3

\*

250























> È possibile richiedere dimensioni fuori serie, contattando il nostro ufficio tecnico. Per le versioni in alluminio verniciato e con laminato è possibile richiedere colori a campione, contattando il nostro ufficio commerciale per fattibilità, costo e quantitativi minimi per ordine. Tutte le dimensioni ed i pesi sono soggetti alle normali tolleranze commerciali.

> Contact our technical office for any non-standard dimensions. Sample colours are available for versions in painted aluminium or laminate. Contact our sales office for feasibility, costs and minimum order quantities. All dimensions and weights are subject to the normal commercial tolerances.

\* I volumi saranno calcolabili dall'azienda solo a preventivo. > The volumes will be calculated by the company for the quotation only. \*\*art. 8 dpr 26/10/72 n° 633 e succ. mod. dpr 29/01/79 n°24 del 31/03/94

# LOCO

Bracciolo.  
Armrest.

			FINITURE > FINISHES			
			CODICE ARTICOLO			Alluminio naturale anodizzato.
			ITEM CODE			Natural anodised aluminium.
						IVA non imponibile > Not subject to VAT **
 120 (1/2)	 4 x 0,3		LOB1	2		
			LOB2	4		
 180 (2/4)	 4 x 0,3		LOB2	3		
			LOB4	6		
 240 (3/6)	 4 x 0,3		LOB3	4		
			LOB6	8		
 300 (4/8)	 4 x 0,3		LOB4	5		
			LOB8	10		
 360 (5/10)	 4 x 0,3		LOB5	6		
			LOB10	12		



















> È possibile richiedere dimensioni fuori serie, contattando il nostro ufficio tecnico. Per le versioni in alluminio verniciato e con laminato è possibile richiedere colori a campione, contattando il nostro ufficio commerciale per fattibilità, costo e quantitativi minimi per ordine. Tutte le dimensioni ed i pesi sono soggetti alle normali tolleranze commerciali.

> Contact our technical office for any non-standard dimensions. Sample colours are available for versions in painted aluminium or laminate. Contact our sales office for feasibility, costs and minimum order quantities. All dimensions and weights are subject to the normal commercial tolerances.

\* I volumi saranno calcolabili dall'azienda solo a preventivo. > The volumes will be calculated by the company for the quotation only. \*\*art. 8 dpr 26/10/72 n° 633 e succ. mod. dpr 29/01/79 n°24 del 31/03/94

# LOCO

Bracciolo.  
Armrest.

			FINITURE > FINISHES		
			CODICE ARTICOLO		
			ITEM CODE		
					Alluminio naturale anodizzato.
					Natural anodised aluminium.
					IVA non imponibile > Not subject to VAT **
			LOB6	6	
420 [1/2]	4 x 0,3		LOB12	12	
			LOB7	7	
480 [2/4]	4 x 0,3		LOB14	14	
			LOB8	8	
540 [3/6]	4 x 0,3		LOB16	16	
			LOB9	9	
600 [4/8]	4 x 0,3		LOB18	18	





> È possibile richiedere dimensioni fuori serie, contattando il nostro ufficio tecnico. Per le versioni in alluminio verniciato e con laminato è possibile richiedere colori a campione, contattando il nostro ufficio commerciale per fattibilità, costo e quantitativi minimi per ordine. Tutte le dimensioni ed i pesi sono soggetti alle normali tolleranze commerciali.

> Contact our technical office for any non-standard dimensions. Sample colours are available for versions in painted aluminium or laminate. Contact our sales office for feasibility, costs and minimum order quantities. All dimensions and weights are subject to the normal commercial tolerances.





\* I volumi saranno calcolabili dall'azienda solo a preventivo. > The volumes will be calculated by the company for the quotation only. \*\*art. 8 dpr 26/10/72 n° 633 e succ. mod. dpr 29/01/79 n°24 del 31/03/94

# LOCO

Cestino.  
Trash Bin.

		FINITURE > FINISHES			
		Kg	m <sup>3</sup>		
		IVA non imponibile > Not subject to VAT **			
CODICE ARTICOLO	ITEM CODE				
	 36 x 36 x 34,5	LOC1	8	*	200
	 36 x 36 x 34,5	LOC2	16	*	400

Piano d'appoggio.  
Table.

	 45 x 45	LOA1	5	*	
	 45 x 45	LOA2	10	*	

> È possibile richiedere dimensioni fuori serie, contattando il nostro ufficio tecnico. Per le versioni in alluminio verniciato e con laminato è possibile richiedere colori a campione, contattando il nostro ufficio commerciale per fattibilità, costo e quantitativi minimi per ordine. Tutte le dimensioni ed i pesi sono soggetti alle normali tolleranze commerciali.

> Contact our technical office for any non-standard dimensions. Sample colours are available for versions in painted aluminium or laminate. Contact our sales office for feasibility, costs and minimum order quantities. All dimensions and weights are subject to the normal commercial tolerances.

\* I volumi saranno calcolabili dall'azienda solo a preventivo. > The volumes will be calculated by the company for the quotation only. \*\*art. 8 dpr 26/10/72 n° 633 e succ. mod. dpr 29/01/79 n°24 del 31/03/94

# LOCO

## A Cestino portarifiuti con attacco a muro. Wall mounted bin.



36 x 36 x 54



Con coperchio.  
With cover.

36 x 36 x 54

## B Cestino portarifiuti con palo. Litter bin supported by a aluminium liners.



36 x 36 x 54



Con coperchio.  
With cover.

36 x 36 x 54





Con coperchio e posacenere.  
With cover and ashtray.

36 x 36 x 54



90 x 90 x 54



		FINITURE > FINISHES		
	<b>CODICE ARTICOLO</b>	 		Cestino, coperchio e posacenere in acciaio zincato e verniciato da esterno. Palo in alluminio anodizzato argento.
	<b>ITEM CODE</b>			Bin , cover and ashtray galvanised steel and brown embossing powder. Aluminium liners anodised natural aluminium.
				IVA non imponibile > Not subject to VAT **
	<b>LOCPA1</b>	12	*	<b>250</b>
	<b>LOCPA2</b>	16	*	<b>350</b>
	<b>LOCPB1</b>	16	*	<b>450</b>
	<b>LOCPB2</b>	20	*	<b>550</b>
	<b>LOCPB3</b>	23	*	<b>690</b>
	<b>LOPC1</b>	40	*	<b>950</b>













> È possibile richiedere dimensioni fuori serie, contattando il nostro ufficio tecnico. Per le versioni in alluminio verniciato e con laminato è possibile richiedere colori a campione, contattando il nostro ufficio commerciale per fattibilità, costo e quantitativi minimi per ordine. Tutte le dimensioni ed i pesi sono soggetti alle normali tolleranze commerciali.

> Contact our technical office for any non-standard dimensions. Sample colours are available for versions in painted aluminium or laminate. Contact our sales office for feasibility, costs and minimum order quantities. All dimensions and weights are subject to the normal commercial tolerances.

\* I volumi saranno calcolabili dall'azienda solo a preventivo. > The volumes will be calculated by the company for the quotation only. \*\*art. 8 dpr 26/10/72 n° 633 e succ. mod. dpr 29/01/79 n°24 del 31/03/94

# LOCO

Elemento portabiciclette.  
Cycle Holder.

		CODICE ARTICOLO	ITEM CODE				FINITURE > FINISHES	
							Alluminio anodizzato naturale. Cerchi in acciaio zincato verniciati rosso RAL 3002.	
						IVA non imponibile > Not subject to VAT **		
 120 x 45	 30 x 45	LOP4	4	10	*	750		
 180 x 45	 30 x 45	LOP6	6	14	*	890		
 240 x 45	 30 x 45	LOP8	8	18	*	1.040		
 300 x 45	 30 x 45	LOP10	10	22	*	1.200		
 360 x 45	 30 x 45	LOP12	12	26	*	1.320		











> È possibile richiedere dimensioni fuori serie, contattando il nostro ufficio tecnico. Per le versioni in alluminio verniciato e con laminato è possibile richiedere colori a campione, contattando il nostro ufficio commerciale per fattibilità, costo e quantitativi minimi per ordine. Tutte le dimensioni ed i pesi sono soggetti alle normali tolleranze commerciali.

> Contact our technical office for any non-standard dimensions. Sample colours are available for versions in painted aluminium or laminate. Contact our sales office for feasibility, costs and minimum order quantities. All dimensions and weights are subject to the normal commercial tolerances.

\* I volumi saranno calcolabili dall'azienda solo a preventivo. > The volumes will be calculated by the company for the quotation only. \*\*art. 8 DPR 26/10/72 n° 633 e succ. mod. DPR 29/01/79 n°24 del 31/03/94

# LOCO

Elemento portabiciclette.  
Cycle Holder.

		CODICE ARTICOLO	ITEM CODE				FINITURE > FINISHES	
							Alluminio anodizzato naturale. Cerchi in acciaio zincato verniciati rosso RAL 3002.	
						IVA non imponibile > Not subject to VAT **		
		LOP14	14	30	*	1.490		
420 x 45	30 x 45							
		LOP16	16	34	*	1.620		
480 x 45	30 x 45							
		LOP18	18	38	*	1.770		
540 x 45	30 x 45							
		LOP20	20	42	*	1.920		
600 x 45	30 x 45							

> È possibile richiedere dimensioni fuori serie, contattando il nostro ufficio tecnico. Per le versioni in alluminio verniciato e con laminato è possibile richiedere colori a campione, contattando il nostro ufficio commerciale per fattibilità, costo e quantitativi minimi per ordine. Tutte le dimensioni ed i pesi sono soggetti alle normali tolleranze commerciali.







> Contact our technical office for any non-standard dimensions. Sample colours are available for versions in painted aluminium or laminate. Contact our sales office for feasibility, costs and minimum order quantities. All dimensions and weights are subject to the normal commercial tolerances.

\* I volumi saranno calcolabili dall'azienda solo a preventivo. > The volumes will be calculated by the company for the quotation only. \*\*art. 8 dpr 26/10/72 n° 633 e succ. mod. dpr 29/01/79 n°24 del 31/03/94

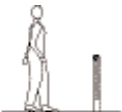

# LOCO

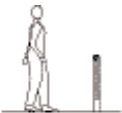
Sistemi informativi orizzontali.  
Information boards

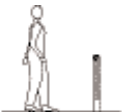
		CODICE ARTICOLO	Kg	m <sup>3</sup>	FINITURE > FINISHES
					ITEM CODE
 120 x H 90	 90 X 120	CIO1	24	*	970
 180 x H 90	 90 X 180	CIO2	33	*	1.160
 240 x H 90	 90 X 240	CIO3	42	*	1.270
 300 x H 90	 90 X 300	CIO4	50	*	1.460



› È possibile richiedere dimensioni fuori serie, contattando il nostro ufficio tecnico. Per le versioni in alluminio verniciato e con laminato è possibile richiedere colori a campione, contattando il nostro ufficio commerciale per fattibilità, costo e quantitativi minimi per ordine. Tutte le dimensioni ed i pesi sono soggetti alle normali tolleranze commerciali.

› Contact our technical office for any non-standard dimensions. Sample colours are available for versions in painted aluminium or laminate. Contact our sales office for feasibility, costs and minimum order quantities. All dimensions and weights are subject to the normal commercial tolerances.

\* I volumi saranno calcolabili dall'azienda solo a preventivo. › The volumes will be calculated by the company for the quotation only. \*\*art. 8 dpr 26/10/72 n° 633 e succ. mod. dpr 29/01/79 n°24 del 31/03/94

# LOCO

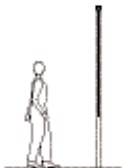
Sistemi informativi verticali.  
Information boards.

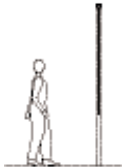







		CODICE ARTICOLO	Kg	m <sup>2</sup>	FINITURE > FINISHES
					ITEM CODE
 <p>80 x H 260</p>	 <p>80 X 260</p>	CIV1	25	*	Alluminio anodizzato naturale  Natural anodised Aluminium  <b>1.390</b>
 <p>120 x H 260</p>	 <p>120 X 260</p>	CIV2	40	*	<b>1.620</b>

> È possibile richiedere dimensioni fuori serie, contattando il nostro ufficio tecnico. Per le versioni in alluminio verniciato e con laminato è possibile richiedere colori a campione, contattando il nostro ufficio commerciale per fattibilità, costo e quantitativi minimi per ordine. Tutte le dimensioni ed i pesi sono soggetti alle normali tolleranze commerciali.  
> Contact our technical office for any non-standard dimensions. Sample colours are available for versions in painted aluminium or laminate. Contact our sales office for feasibility, costs and minimum order quantities. All dimensions and weights are subject to the normal commercial tolerances.

\* I volumi saranno calcolabili dall'azienda solo a preventivo. > The volumes will be calculated by the company for the quotation only. \*\*art. 8 dpr 26/10/72 n° 633 e succ. mod. dpr 29/01/79 n°24 del 31/03/94

# LOCO

Postazione wifi.  
Wifi station.

		CODICE ARTICOLO	PERSONE	Kg	m <sup>3</sup>	FINITURE > FINISHES	
						ITEM CODE	Aluminio anodizzato naturale  Natural anodised Aluminium
						IVA non imponibile > Not subject to VAT **	
		LO2WF	4	21	*	1.010	1.090
120 x 105	41 x 105						
		LO6WF	6	30	*	1.230	1.350
180 x 105	41 x 105						
		LO8WF	8	39	*	1.450	1.600
240 x 105	41 x 105						
		LO10WF	10	48	*	1.680	1.860
300 x 105	41 x 105						









> È possibile richiedere dimensioni fuori serie, contattando il nostro ufficio tecnico. Per le versioni in alluminio verniciato e con laminato è possibile richiedere colori a campione, contattando il nostro ufficio commerciale per fattibilità, costo e quantitativi minimi per ordine. Tutte le dimensioni ed i pesi sono soggetti alle normali tolleranze commerciali.

> Contact our technical office for any non-standard dimensions. Sample colours are available for versions in painted aluminium or laminate. Contact our sales office for feasibility, costs and minimum order quantities. All dimensions and weights are subject to the normal commercial tolerances.

\* I volumi saranno calcolabili dall'azienda solo a preventivo. > The volumes will be calculated by the company for the quotation only. \*\*art. 8 DPR 26/10/72 n° 633 e succ. mod. DPR 29/01/79 n°24 del 31/03/94

# LOCO

**A** Complesso picnic singolo.  
Single picnic table.









		CODICE ARTICOLO	PERSONE	Kg	m <sup>2</sup>	FINITURE > FINISHES	
						ITEM CODE	Alluminio anodizzato naturale
						IVA non imponibile > Not subject to VAT **	
		LO4PCA	2	90	*	2.520	2.730
120 x 125 x 73	125 x 73						
		LO6PCA	3	112	*	3.150	3.360
180 x 125 x 73	125 x 73						
		LO8PCA	4	134	*	3.680	3.960
240 x 125 x 73	125 x 73						
		LO10PCA	5	156	*	4.270	4.550
300 x 125 x 73	125 x 73						

> È possibile richiedere dimensioni fuori serie, contattando il nostro ufficio tecnico. Per le versioni in alluminio verniciato e con laminato è possibile richiedere colori a campione, contattando il nostro ufficio commerciale per fattibilità, costo e quantitativi minimi per ordine. Tutte le dimensioni ed i pesi sono soggetti alle normali tolleranze commerciali.  
> Contact our technical office for any non-standard dimensions. Sample colours are available for versions in painted aluminium or laminate. Contact our sales office for feasibility, costs and minimum order quantities. All dimensions and weights are subject to the normal commercial tolerances.

\* I volumi saranno calcolabili dall'azienda solo a preventivo. > The volumes will be calculated by the company for the quotation only. \*\*art. 8 dpr 26/10/72 n° 633 e succ. mod. dpr 29/01/79 n°24 del 31/03/94

# LOCO

**B** Complesso picnic doppio.  
Double picnic table.

		CODICE ARTICOLO	PERSONS PERSONS	Kg	m <sup>3</sup>	FINITURE > FINISHES	
						ITEM CODE	Aluminio anodizzato naturale
						IVA non imponibile > Not subject to VAT **	
 120 x 170 x 73	 170 x 73	LO4PCB	4	130	*	3.510	3.790
 180 x 170 x 73	 170 x 73	LO6PCB	6	160	*	4.380	4.660
 240 x 170 x 73	 170 x 73	LO8PCB	8	190	*	5.120	5.490
 300 x 170 x 73	 170 x 73	LO10PCB	10	220	*	5.930	6.300









> È possibile richiedere dimensioni fuori serie, contattando il nostro ufficio tecnico. Per le versioni in alluminio verniciato e con laminato è possibile richiedere colori a campione, contattando il nostro ufficio commerciale per fattibilità, costo e quantitativi minimi per ordine. Tutte le dimensioni ed i pesi sono soggetti alle normali tolleranze commerciali.

> Contact our technical office for any non-standard dimensions. Sample colours are available for versions in painted aluminium or laminate. Contact our sales office for feasibility, costs and minimum order quantities. All dimensions and weights are subject to the normal commercial tolerances.

\* I volumi saranno calcolabili dall'azienda solo a preventivo. > The volumes will be calculated by the company for the quotation only. \*\*art. 8 dpr 26/10/72 n° 633 e succ. mod. dpr 29/01/79 n°24 del 31/03/94

# QTAB01

Fioriera.  
Flower box.

		FINITURE > FINISHES			
		Kg	m <sup>2</sup>	Fioriera in acciaio zincato e verniciato bronzo gofrato. Pali in alluminio anodizzato argento.	
				Flower box galvanised steel and brown embossing powder. Aluminium liners natural anodised.	
		IVA non imponibile > Not subject to VAT **			
  58,5 x 58,5 x 56,5	 58,5 X 56,5	LOF1	28	*	735
  800 x 58,5 x 56,5	 58,5 X 56,5	LOF2	32	*	780
  120 x 58,5 x 56,5	 58,5 X 56,5	LOF3	41	*	880

› È possibile richiedere dimensioni fuori serie, contattando il nostro ufficio tecnico. Per le versioni in alluminio verniciato e con laminato è possibile richiedere colori a campione, contattando il nostro ufficio commerciale per fattibilità, costo e quantitativi minimi per ordine. Tutte le dimensioni ed i pesi sono soggetti alle normali tolleranze commerciali.  
› Contact our technical office for any non-standard dimensions. Sample colours are available for versions in painted aluminium or laminate. Contact our sales office for feasibility, costs and minimum order quantities. All dimensions and weights are subject to the normal commercial tolerances.

\* I volumi saranno calcolabili dall'azienda solo a preventivo. › The volumes will be calculated by the company for the quotation only. \*\*art. 8 dpr 26/10/72 n° 633 e succ. mod. dpr 29/01/79 n°24 del 31/03/94

